

# EFI Hardware Part Number: 855-646H

## Product Update

FI114961 61 lb/hr Deko IV Long Minitimer



### Features

Fuel Compatibility	Standard Gasolines & Ethanol Flex Fuels
Fuel Pressure	300 kPa
Static Flow Rate	n-Heptane: 7.64 g/sec (61 lb/hr, 668 cc)
Dynamic Flow Rate	n-Heptane: mg/pulse (15.7 mg/pulse 2.5 ms PW, 20 ms Period)
Offset	0.67 ms
Minimum Linear PW	1.5 ms
Linear Flow Range (SAE)	8.43
Opening/Closing Time	1.3 ms / 0.7 ms
Coil Resistance	12.0 •
Injector Inductance	11.6 mH
SMOV/DMOV	4.42 V / 4.92 V
Connector	Minitimer
Spray Pattern	26° Cone
Installation Compatibility	Deko I, IV Long, V Long, & VII Long Installation Compatible
Identification Shell Color	Black

### Connector



Minitimer

### Basic Dimensions

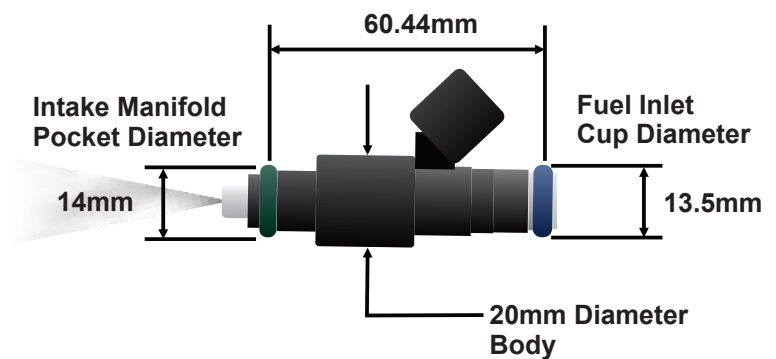

**VDO**

# EFI Hardware Part Number: 855-646H

## Spray Characteristics (4 Hole Orifice)

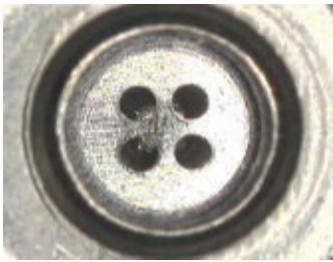
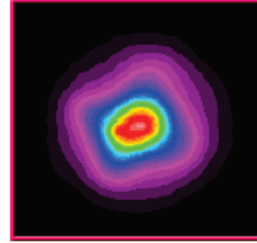
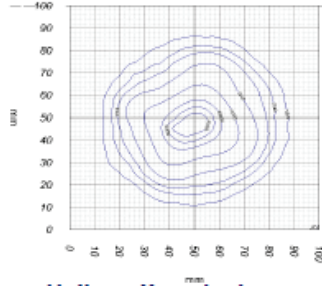

## Voltage Sensitivity

Voltage Sensitivity Summary, 6-16V

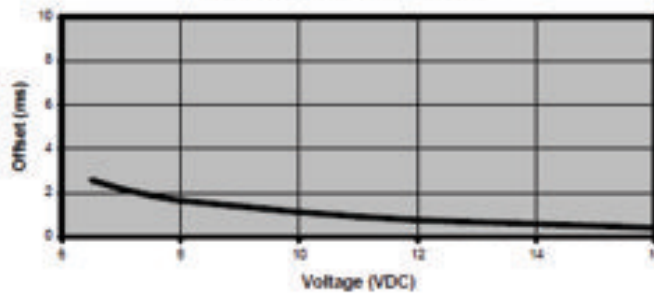

## Linearity

Characteristic Injector Flow

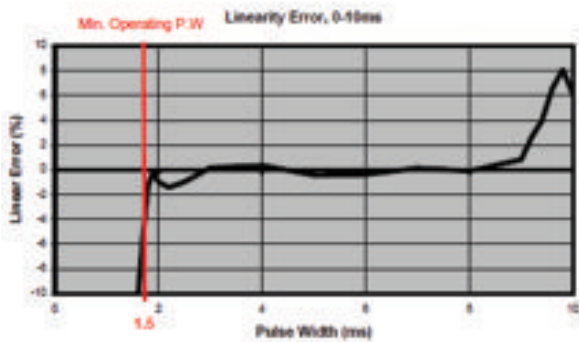
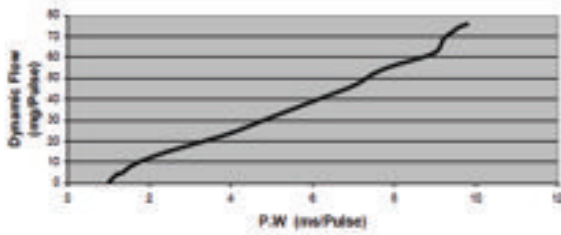

VDO